

AUSTRALASIAN HFG STANDARD COMPONENTS

Room Layout Sheet

RLS Room Code: **ANPR**

Room Name:

ANGIOGRAPHY PROCEDURE ROOM

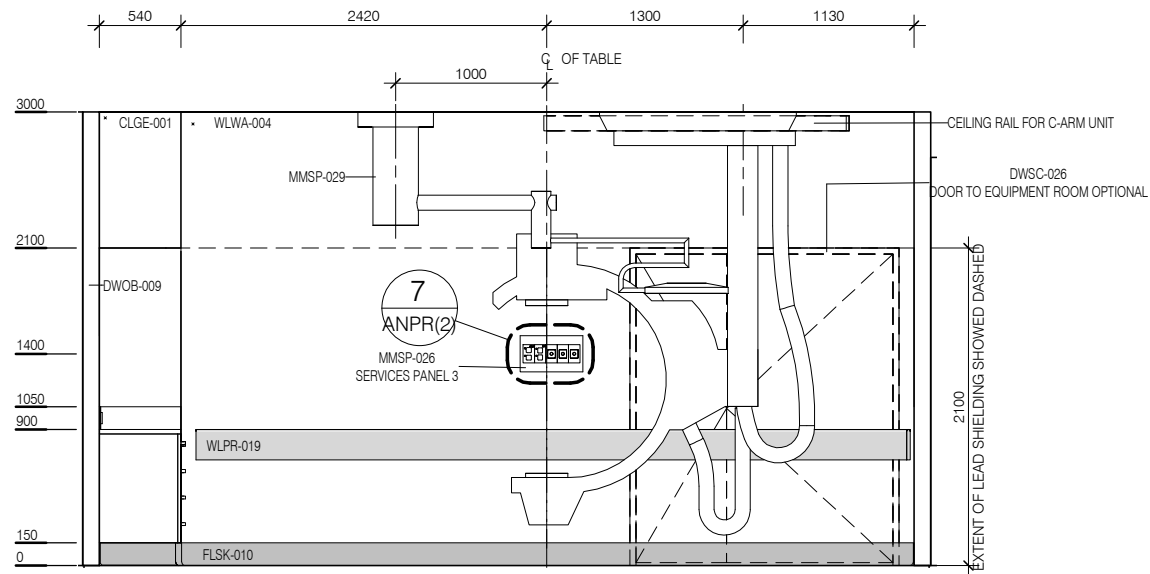
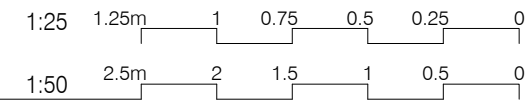

ELEVATION 1

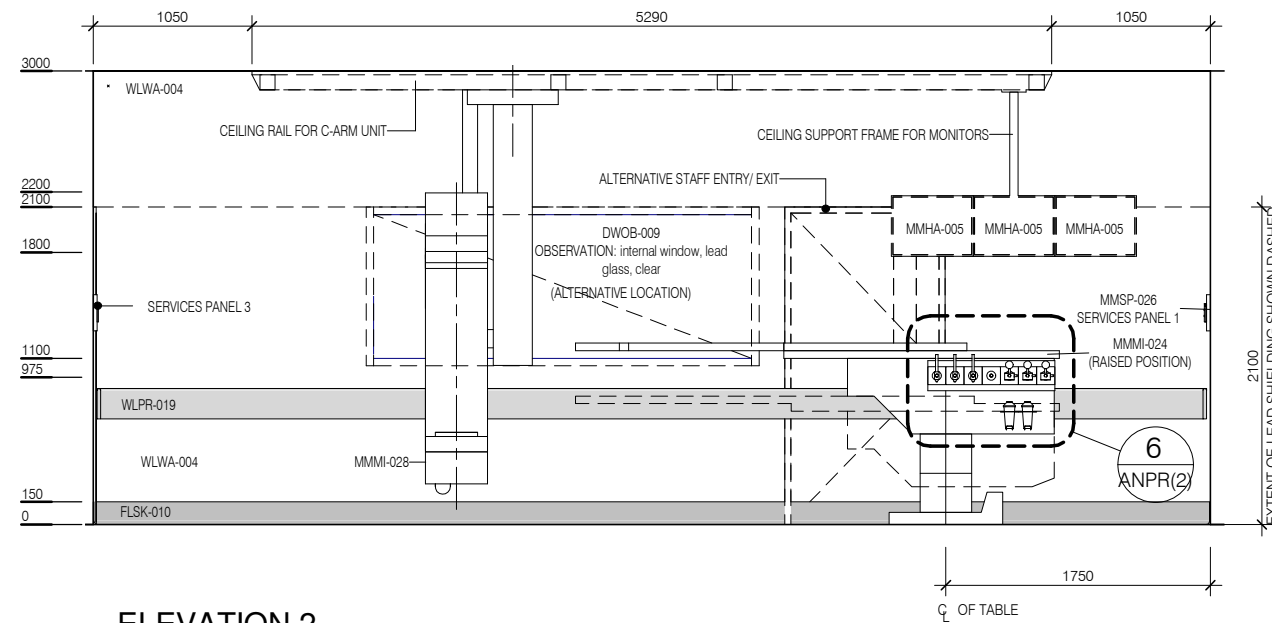

ELEVATION 2

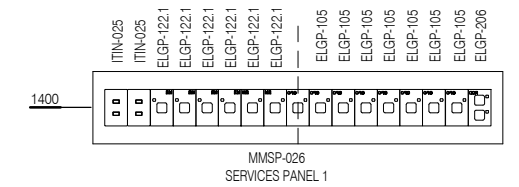

ELEVATION 5 (1 : 25 @ A3)

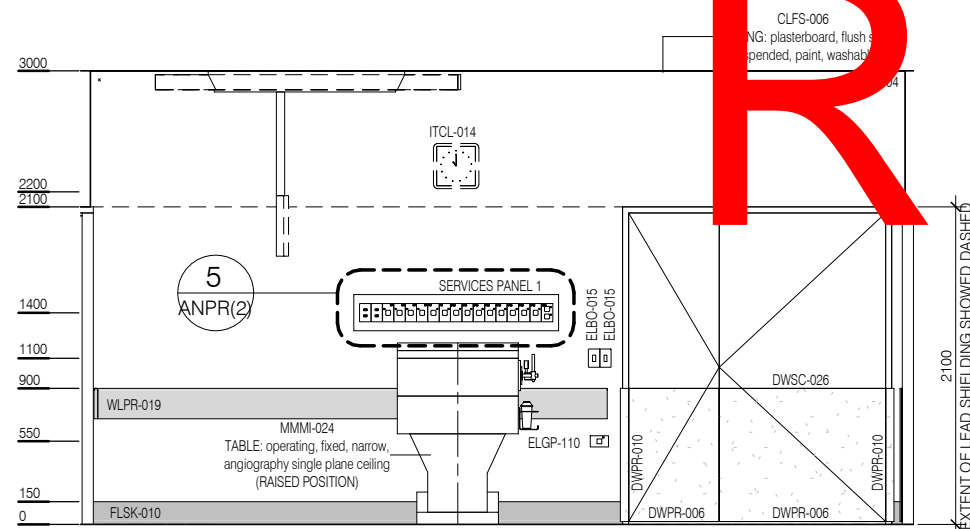

ELEVATION 3

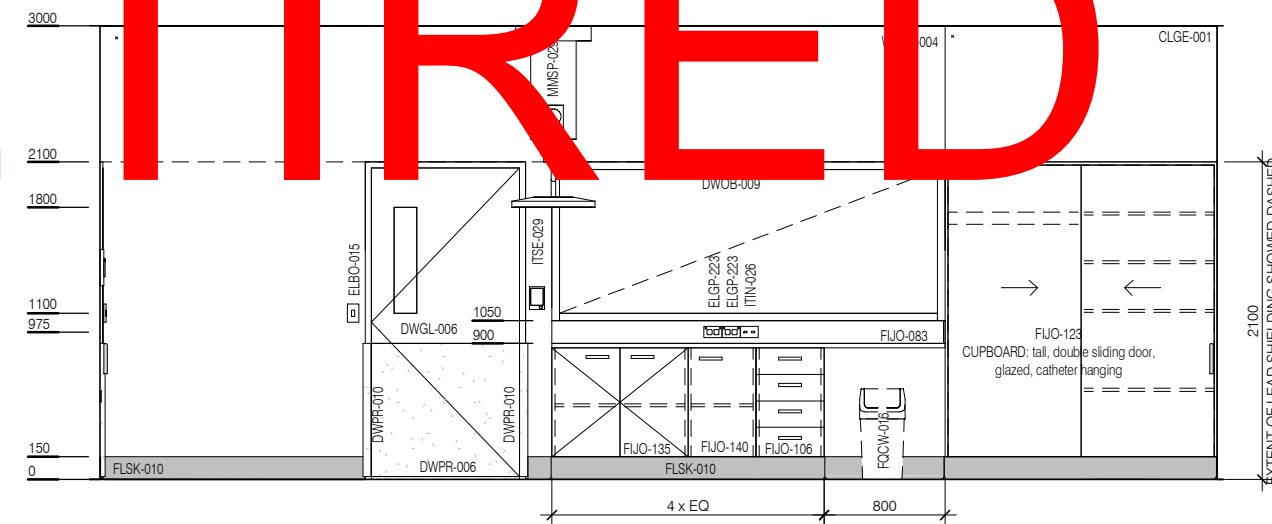

ELEVATION 4

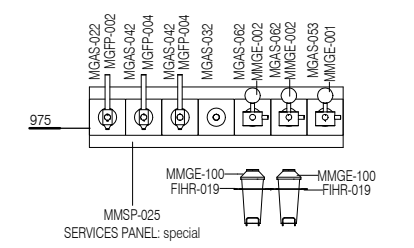

ELEVATION 6 (1 : 25 @ A3)

CODE	DESCRIPTION
DWGL-006	DOOR: 910mm c/o, single leaf, observation panel, solid core/lead glass, lead shielding, paint
DWOB-009	OBSERVATION: internal window, lead glass, clear
DWPR-006	DOOR PROTECTION: protection plate, to 900 AFFL, PVC, prefinished
DWPR-010	DOOR PROTECTION: to door frame, PVC, prefinished
DWSC-026	DOOR: 1600mm c/o, 1 1/2 leaf, solid core, lead shielding, paint
ELBO-015	SWITCH: light, single
ELGP-105	GPO: single, on services panel
ELGP-110	GPO: single, wall mounted, cleaner
ELGP-122.1	GPO: emergency power, single, on services panel (V)
ELGP-206	GPO: double, on services panel, RCD protected
ELGP-222.1	GPO: emergency power, double, on services panel (V)
ELGP-223	GPO: emergency power, double, wall mounted
ELPR-002	CARDIAC PROTECTED ELECTRICAL AREA
FIHR-019	BRACKET: for suction bottle
FIJO-083	BENCH TOP: special depth, joinery under, laminate finish
FIJO-106	CUPBOARD: drawer unit, 4 equal
FIJO-123	CUPBOARD: tall, double sliding door, glazed, catheter hanging
FIJO-135	CUPBOARD: underbench, double door, adj shelves

CODE	DESCRIPTION
FIJO-140	CUPBOARD: underbench, single door, adj shelves
FLSK-010	SKIRTING: vinyl, floor vinyl coved, 150H, prefinished
FLVY-007	FLOOR FINISH: vinyl, seamless, coved, standard slip resistant
FQCV-016	BIN: waste, general, 20L
ITCL-004	BUTTON: nurse call, emergency
ITCL-008	BUTTON: nurse call, staff assist
ITCL-009	BUTTON: nurse call, staff / nurse assist
ITCL-014	CLOCK: analogue, electric
ITIN-025	OUTLET: data, double RJ45, on services panel
ITIN-026	OUTLET: data, double RJ45, wall mounted
ITSE-029	INTERCOM: audio, wall mount
MGAS-022	OUTLET: medical air (MA), on services panel
MGAS-032	OUTLET: nitrous oxide (N2O), on services panel
MGAS-042	OUTLET: oxygen (O2), on services panel
MGAS-053	OUTLET: scavenge, on services panel

CODE	DESCRIPTION
MGAS-062	OUTLET: suction, on services panel
MGFP-002	FLOWMETER: medical air
MGFP-004	FLOWMETER: oxygen
MMGE-001	ADAPTER: scavenge
MMGE-002	ADAPTER: suction
MMGE-100	SUCTION BOTTLE
MMHA-005	MONITOR: patient, cardiac
MMMI-024	TABLE: operating, fixed, narrow, angiography single plane ceiling
MMMI-028	SYSTEM: imaging, angiography single plane ceiling
MMS-025	SERVICES PANEL: special
MMS-026	SERVICES PANEL: wall mounted
MMS-029	LIGHT: operating, single, 550 diam nom.
WLPR-019	WALL PROTECTION: crash rail, at 900 AFFL, prefinished PVC
WLSH-004	SHIELDING: lead lining
WLWA-004	WALL FINISH: paint, acrylic, washable

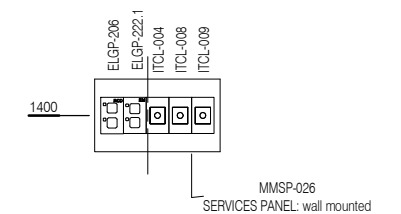

ELEVATION 7 (1 : 25 @ A3)



REV	DESCRIPTION	DATE
3	Coding and naming updated	20.03.2017

FOR GUIDANCE

SCALE	RLS Room Code	REV
1 : 50 @ A3	ANPR	3