

AUSTRALASIAN HFG STANDARD COMPONENTS

Room Layout Sheet

RLS Room Code: **BPATH**

Room Name:

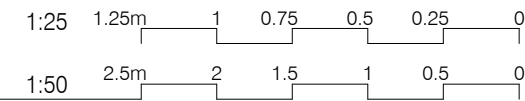

BAY - PATHOLOGY

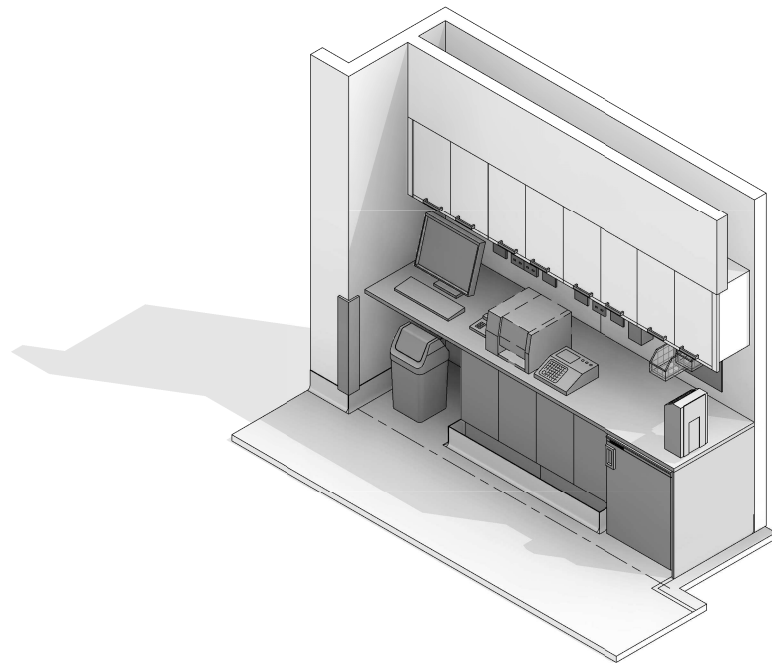

CODE	DESCRIPTION
ELGP-208	GPO: double, wall mounted
ELGP-223	GPO: emergency power, double, wall mounted
FIDI-001	DISPENSER: alcohol based hand rub
FIHR-016	BRACKET: for sharps bin
FIHR-033	PANEL: for storage bins, wall mount
FUJO-069	BENCH TOP: 750D, joinery under, laminate finish
FUJO-135	CUPBOARD: underbench, double door, adj shelves
FUJO-145	CUPBOARD: wall mount, double door, adj shelves, lockable
FLSK-010	SKIRTING: vinyl, floor vinyl coved, 150H, prefinished
FLVY-007	FLOOR FINISH: vinyl, seamless, coved, standard slip resistant
FQCW-005	BIN: waste, clinical, 20L
FQCW-044	BIN: waste, sharps, wall mounted
FQGE-056	PRINTER: desktop, labels
FQSN-006	BIN: storage bins, for wall mounted panel
ITIN-026	OUTLET: data, double RJ45, wall mounted
ITNE-007	COMPUTER: desktop, with display screen
ITNE-049	TELEPHONE: handset, desktop
LIFX-008	LIGHT: task light, built in
MMGE-036	FRIDGE: drugs, underbench
MMLA-049	DEVICE: point of care
WLPR-011	WALL PROTECTION: corner guards, to 900 AFFL min.
WLWA-004	WALL FINISH: paint, acrylic, washable

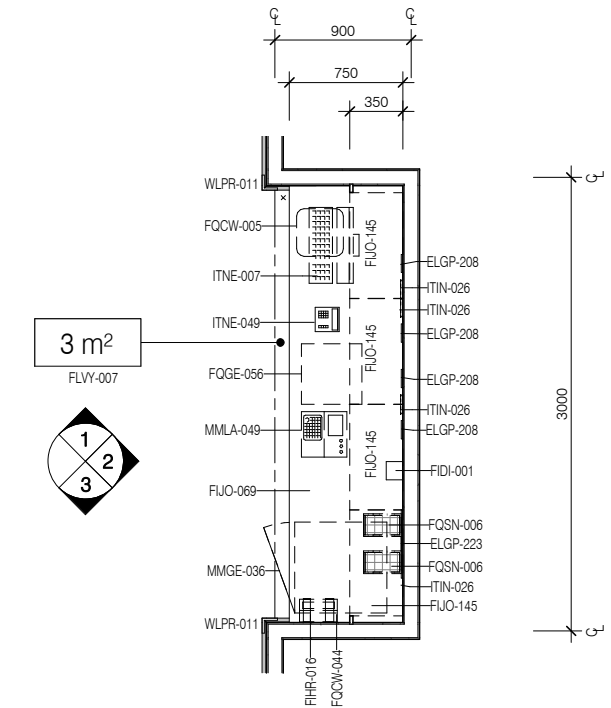

PLAN

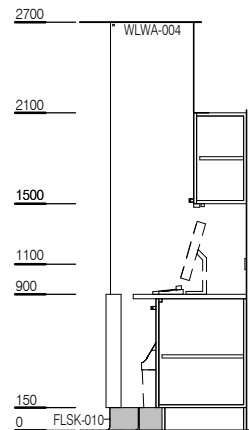

ELEVATION 1

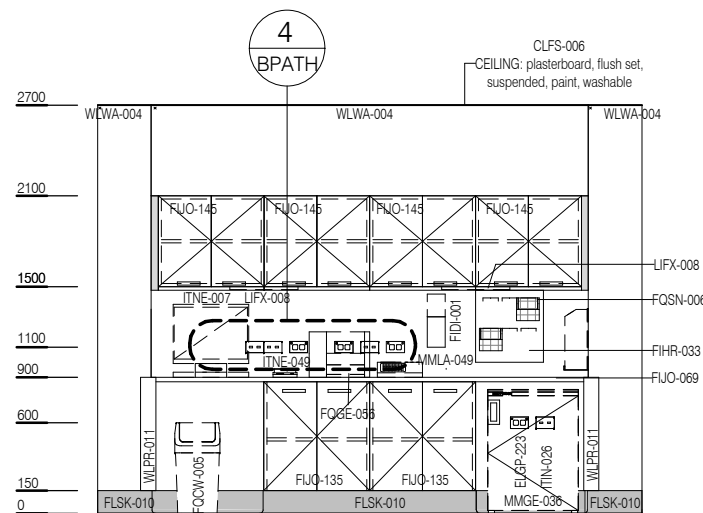

ELEVATION 2

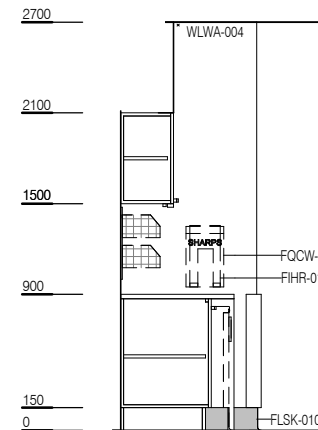

ELEVATION 3

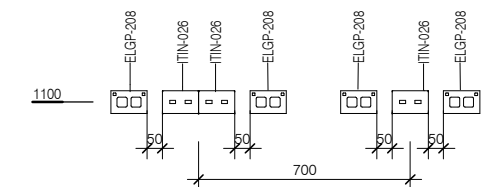

ELEVATION 4 (1 : 25 @ A3)



REV	DESCRIPTION	DATE
2	Coding and naming updated	20.03.2017

FOR GUIDANCE

SCALE	RLS Room Code	REV
1 : 50 @ A3	BPATH	2