

AUSTRALASIAN HFG STANDARD COMPONENTS

Room Layout Sheet

RLS Room Code: **OPG**

Room Name:

OPG ROOM

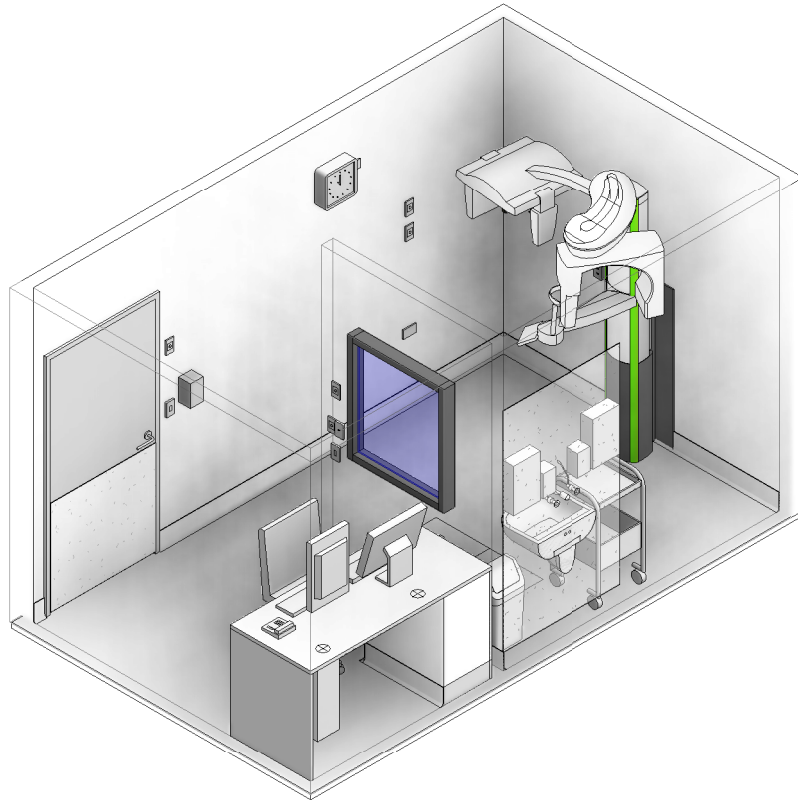

CODE	DESCRIPTION
DWOB-009	OBSERVATION: internal window, lead glass, clear
DWPR-005	DOOR PROTECTION: protection plate to 900 AFFL
ELBO-001	BUTTON: emergency stop
ELBO-012	SWITCH: light, dimmer
ELGP-109	GPO: single, wall mounted
ELGP-110	GPO: single, wall mounted, cleaner
ELGP-223	GPO: emergency power, double, wall mounted
ELGP-223.1	GPO: emergency power, double, wall mounted (V)
ELPR-001	BODY PROTECTED ELECTRICAL AREA
ELPR-006	RCD: residual current device
FIDI-001	DISPENSER: alcohol based hand rub
FIDI-014	DISPENSER: disposable glove
FIDI-025	DISPENSER: paper/hand towel
FIDI-030	DISPENSER: soap
FIDI-031	DISPENSER: soap antiseptic
FIHR-075	BRACKET: for computer CPU, underdesk mounted
FUO-069	BENCH TOP: 750D, joinery under, laminate finish
FUO-099	CAC: cable access cap
FUO-142	CUPBOARD: underbench, single, adj shelves, with single drawer
FLSK-010	SKIRTING: vinyl, floor vinyl coved, 150H, prefinished
FLVY-007	FLOOR FINISH: vinyl, seamless, coved, standard slip resistant
FQBS-019	CHAIR: office, ergonomic, high

CODE	DESCRIPTION
FQBW-016	BIN: waste, general, 20L
FQSM-016	TROLLEY
HYBA-010	BASIN: handwash, Type B
HYTP-037	TAPWARE: mixer, elbow levers
ITCL-004	BUTTON: nurse call, emergency
ITCL-008	BUTTON: nurse call, staff assist
ITCL-014	CLOCK: analogue, electric
ITIN-016	OUTLET: data, single RJ45, wall mounted
ITIN-026	OUTLET: data, double RJ45, wall mounted
ITNE-007	COMPUTER: desktop, with display screen
ITNE-049	TELEPHONE: handset, desktop
ITNE-067	KEYBOARD: keyboard and mouse only
ITNE-068	COMPUTER: hi performance, for clinical / PACS use, CPU, underbench mount
ITNE-069	DISPLAY SCREEN: PACS, portrait
LIFX-002	LIGHT: illuminated sign, "X-Ray in Use"
MMMI-324	DEVICE: imaging, dental imaging unit (OPG/CEPH/CONE BEAM CT)
MMMI-371	BUTTON: dental imaging unit, remote activation
WLSH-004	SHIELDING: lead lining
WLWA-004	WALL FINISH: paint, acrylic, washable
WLWA-010	WALL FINISH: splashback, vinyl

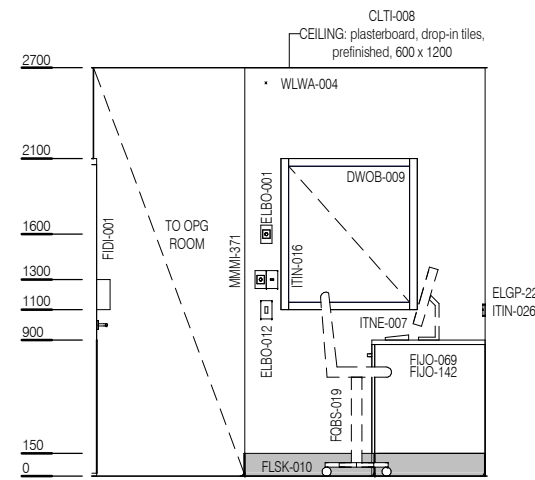
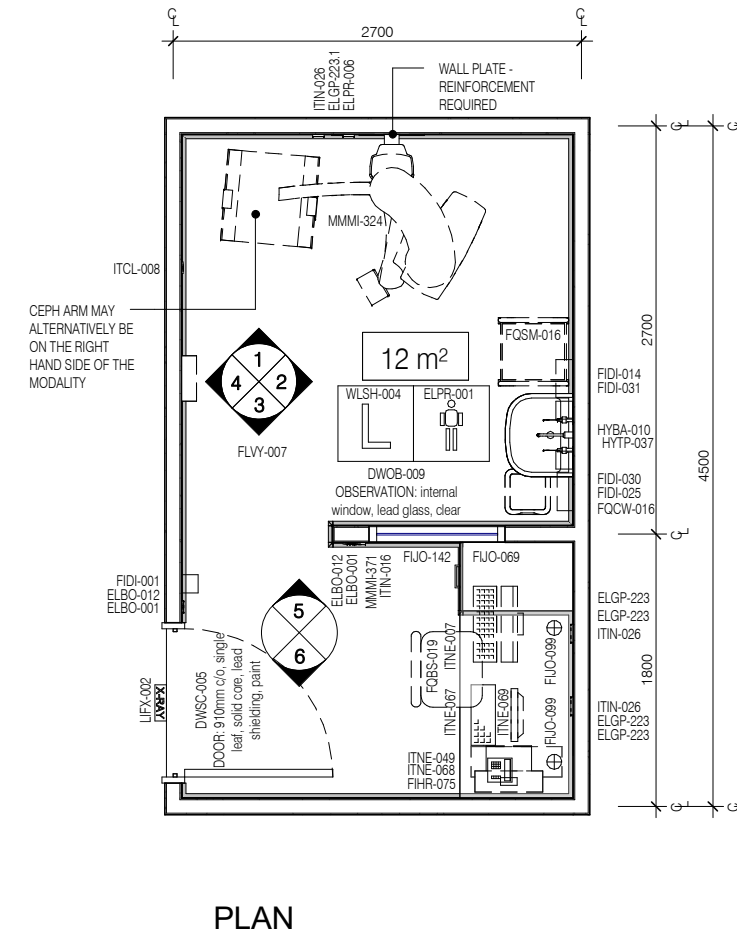

ELEVATION 5

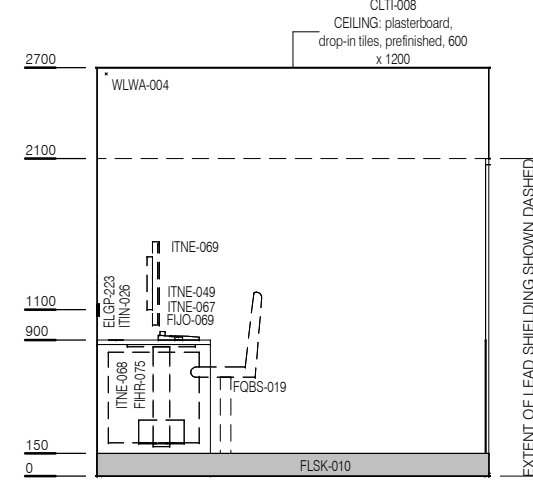

ELEVATION 6

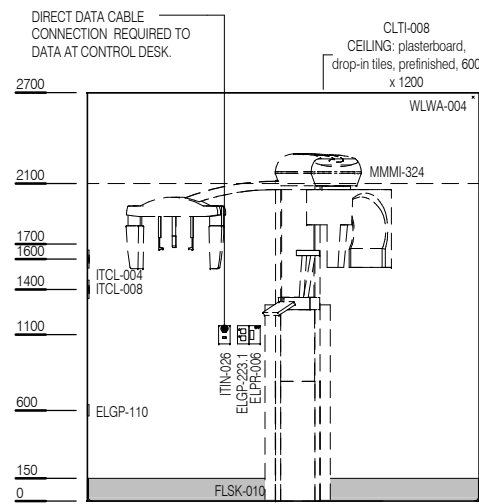

ELEVATION 1

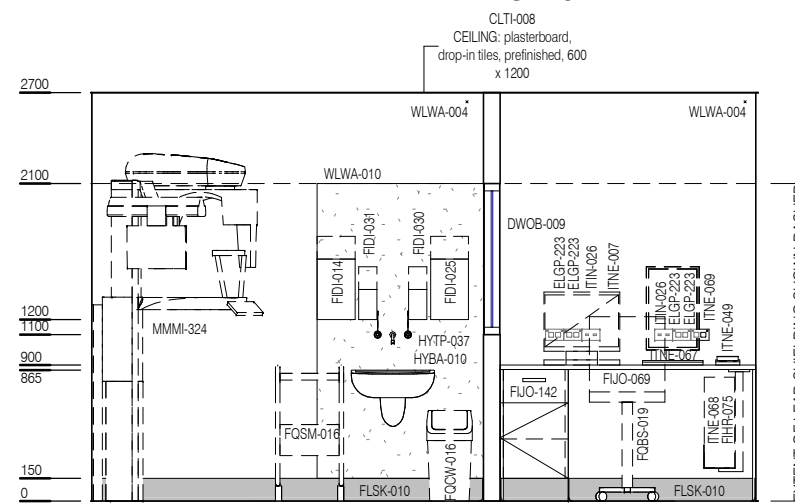

ELEVATION 2

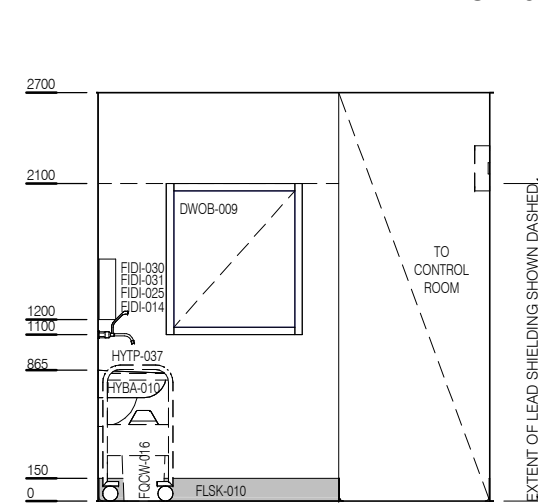

ELEVATION 3

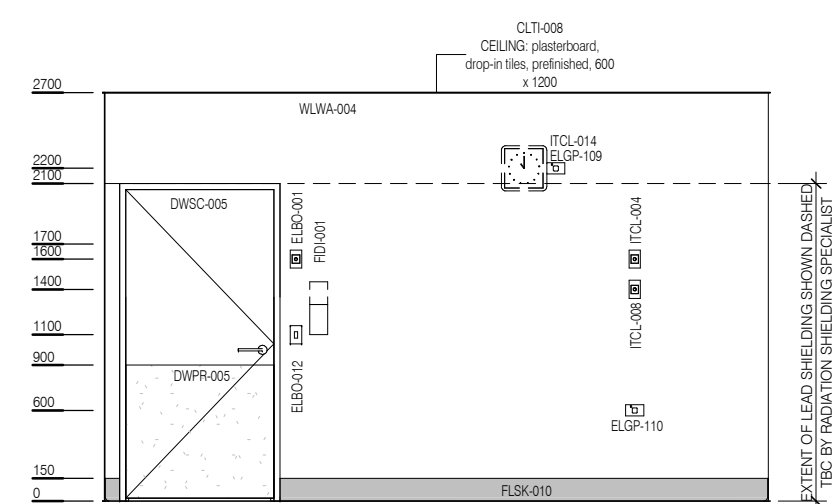

ELEVATION 4



REV	DESCRIPTION	DATE
1	First Issue	29.05.2019

FOR GUIDANCE

SCALE	RLS Room Code	REV
1 : 50 @ A3	OPG	1