

# AUSTRALASIAN HFG STANDARD COMPONENTS

Room Layout Sheet

RLS Room Code: **PBTR-RS1**

Room Name:

**PATIENT BAY - RECOVERY, STAGE 1, 9m<sup>2</sup>**

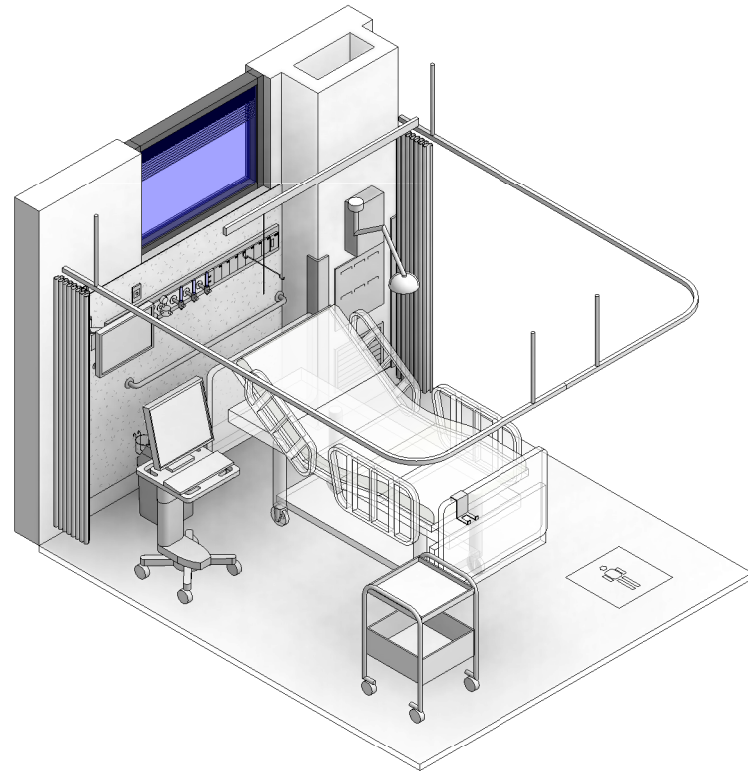
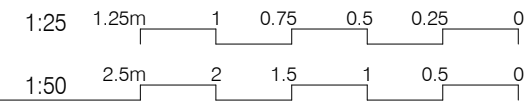

CODE	DESCRIPTION
DWWD-007	BLIND: venetian, integral
DWWH-005	WINDOW
ELBO-015	SWITCH: light, single
ELGP-122.1	GPO: emergency power, single, on services panel (V)
ELGP-223.1	GPO: emergency power, double, wall mounted (V)
ELPR-001	BODY PROTECTED ELECTRICAL AREA
ELPR-006	RCD: residual current device
FIDI-014	DISPENSER: disposable glove
FIHR-019	BRACKET: for suction bottle
FIHR-029	HOOK: equipment
FIHR-033	PANEL: for storage bins, wall mount
FIHR-067	BRACKET: for monitor, wall mounted, articulated, adj height
FIHR-068	BRACKET: for alcohol based hand rub, attached to bed
FIRT-023	TRACK: curtain, bedscreen, L shaped
FIRT-038	TRACK: ceiling mounted, IV, straight
FIRT-043	RAIL: equipment - horizontal
FLSK-010	SKIRTING: vinyl, floor vinyl coved, 150H, prefinished
FLVY-007	FLOOR FINISH: vinyl, seamless, coved, standard slip resistant
FOCW-005	BIN: waste, clinical, 20L
FOGE-009	CURTAIN: bed screen
ITCL-004	BUTTON: nurse call, emergency
ITCL-006	BUTTON: nurse call, patient to staff

CODE	DESCRIPTION
ITCL-008	BUTTON: nurse call, staff assist
ITCL-028	HANDSET: nurse call, with patient to staff call button
ITIN-016	OUTLET: data, single RJ45, wall mounted
ITIN-025	OUTLET: data, double RJ45, on services panel
ITNE-008	COMPUTER: for workstation on wheels
LIFX-013	LIGHT: procedure, ceiling mounted, small
MEEEX-008	EXHAUST: low level
MGAS-022	OUTLET: medical air (MA), on services panel
MGAS-042	OUTLET: oxygen (O2), on services panel
MGAS-062	OUTLET: suction, on services panel
MGFP-002	FLOWMETER: medical air
MGFP-004	FLOWMETER: oxygen
MMBE-010	BED: patient, electric with mattress
MMGE-002	ADAPTER: suction
MMGE-039	HANGER: IV, for ceiling track
MMGE-100	SUCTION BOTTLE
MMGE-119	TROLLEY: equipment
MMGE-164	WORKSTATION ON WHEELS: clinical, mobile
MMHA-008	MONITOR: patient, cardiac with vital signs
MMSP-026	SERVICES PANEL: wall mounted
WLPR-001	WALL PROTECTION: bed protection wall panel
WLPR-010	WALL PROTECTION: corner guards, to 900 AFFL
WLWA-004	WALL FINISH: paint, acrylic, washable

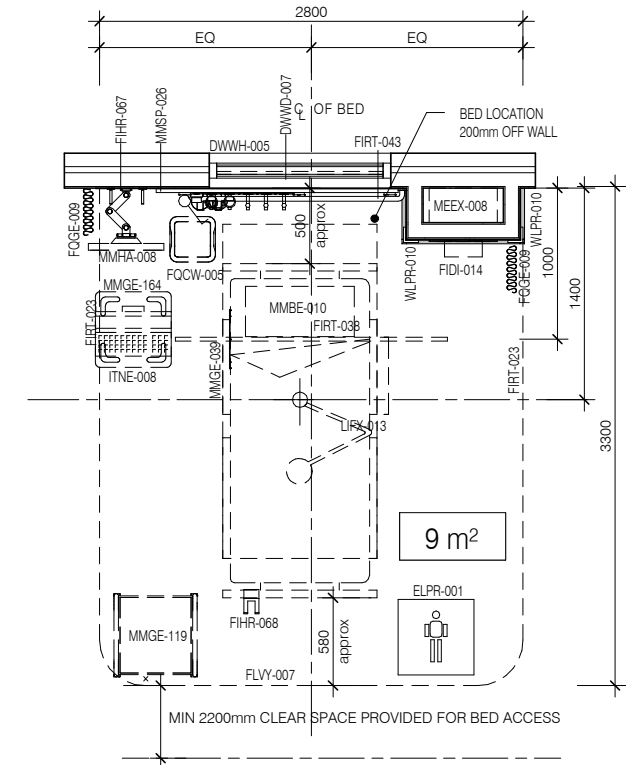

PLAN

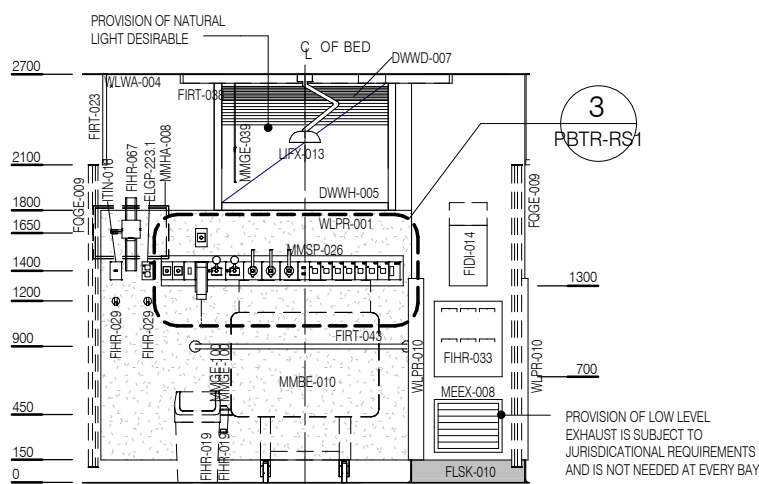
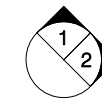

ELEVATION 1

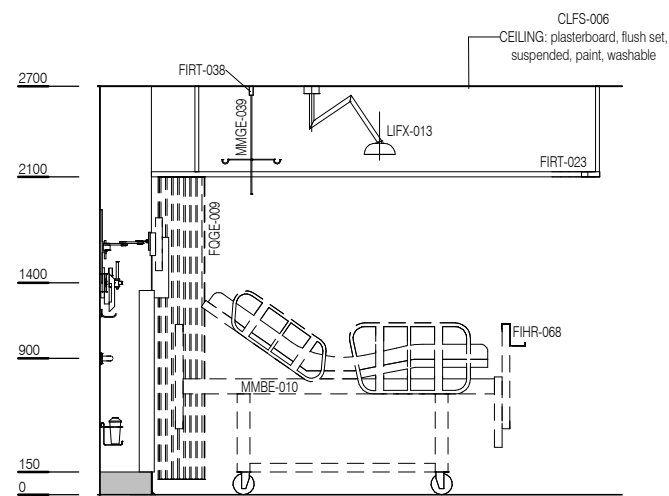

ELEVATION 2

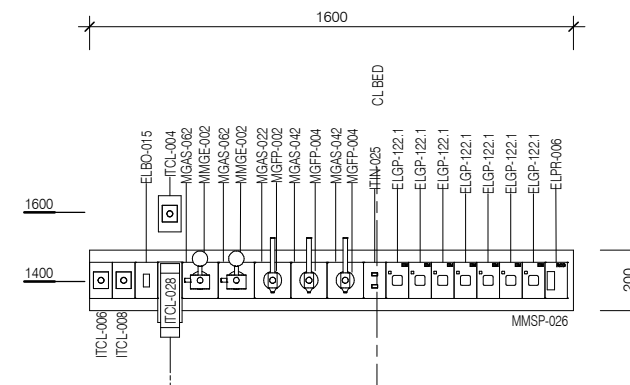

ELEVATION 3



REV	DESCRIPTION	DATE
3	Coding and naming updated	20.03.2017
4	GENERAL UPDATE FOLLOWING ERG.. REVIEW	02.07.2018

FOR GUIDANCE

SCALE	RLS Room Code	REV
1 : 50 @ A3	PBTR-RS1	4