

AUSTRALASIAN HFG STANDARD COMPONENTS

Room Layout Sheet

RLS Room Code: **SSTN-20**

Room Name:

STAFF STATION, 20m²

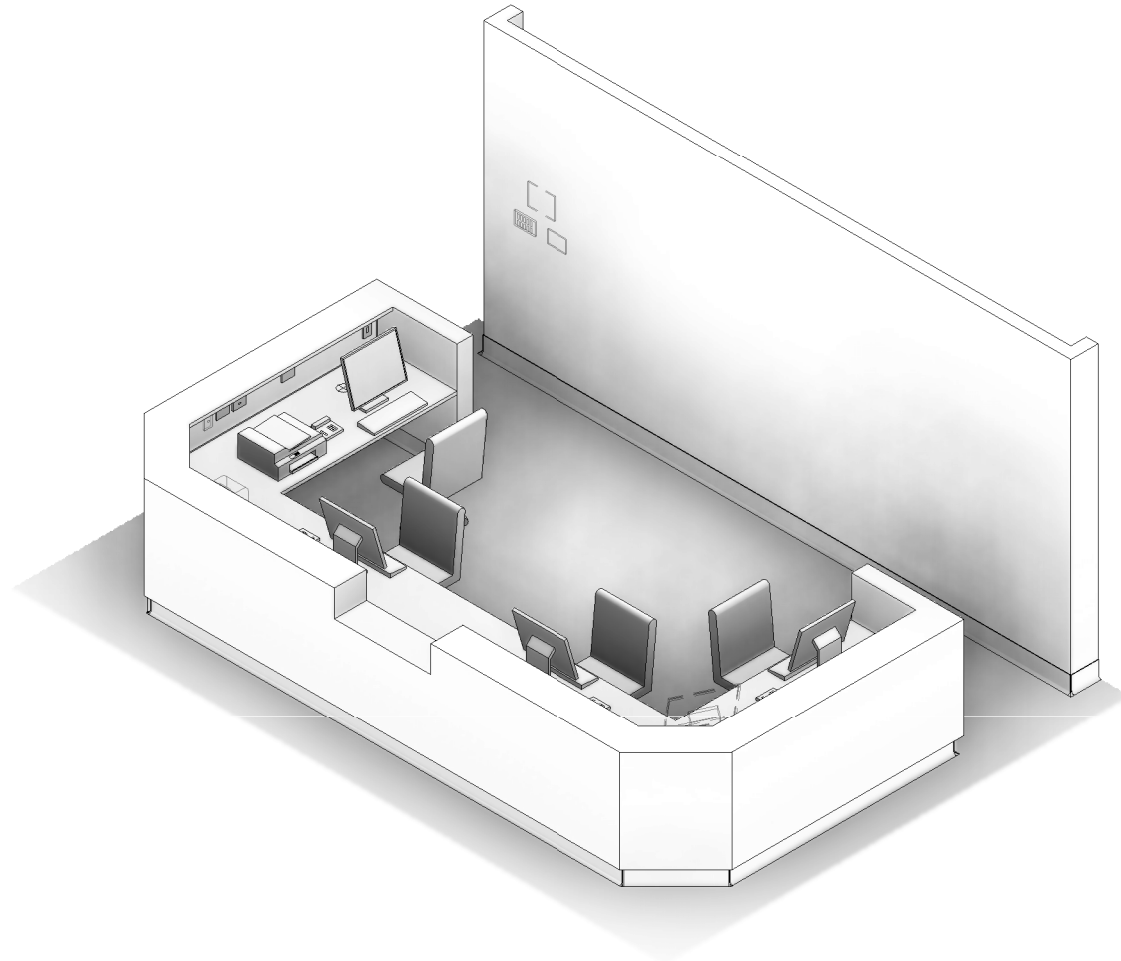
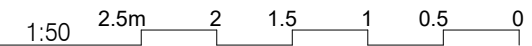

CODE	DESCRIPTION
ELBO-003	CONTROL PANEL: lighting
ELBO-015	SWITCH: light, single
ELGP-130	GPO: UPS, single
ELGP-208	GPO: double, wall mounted
ELGP-223	GPO: emergency power, double, wall mounted
ELGP-235	GPO: UPS, double, wall mounted
ELPR-007	UPS: status indicator
FIBM-019	WHITEBOARD: fixed, magnetic
FUJO-099	CAC: cable access cap
FUJO-178	JOINERY UNIT: staff station
FLSK-010	SKIRTING: vinyl, floor vinyl coved, 150H, prefinished
FQBS-018	CHAIR: office, ergonomic
FQCW-016	BIN: waste, general, 20L
FQGE-056	PRINTER: desktop, labels
FQSM-007	PEDESTAL: mobile, drawer unit, 660H
ITIN-016	OUTLET: data, single RJ45, wall mounted
ITIN-036	OUTLET: data, triple RJ45, wall mounted
ITNE-007	COMPUTER: desktop, with display screen
ITNE-023	PRINTER: networked
ITNE-049	TELEPHONE: handset, desktop
ITSE-006	BUTTON: duress, fixed
LIFX-008	LIGHT: task light, built in
MEGE-007	CONTROL PANEL: temperature
MGFP-001	ALARM PANEL: medical gases
MMGE-187	MONITOR: patient, central monitoring
MLWA-004	WALL FINISH: paint, acrylic, washable

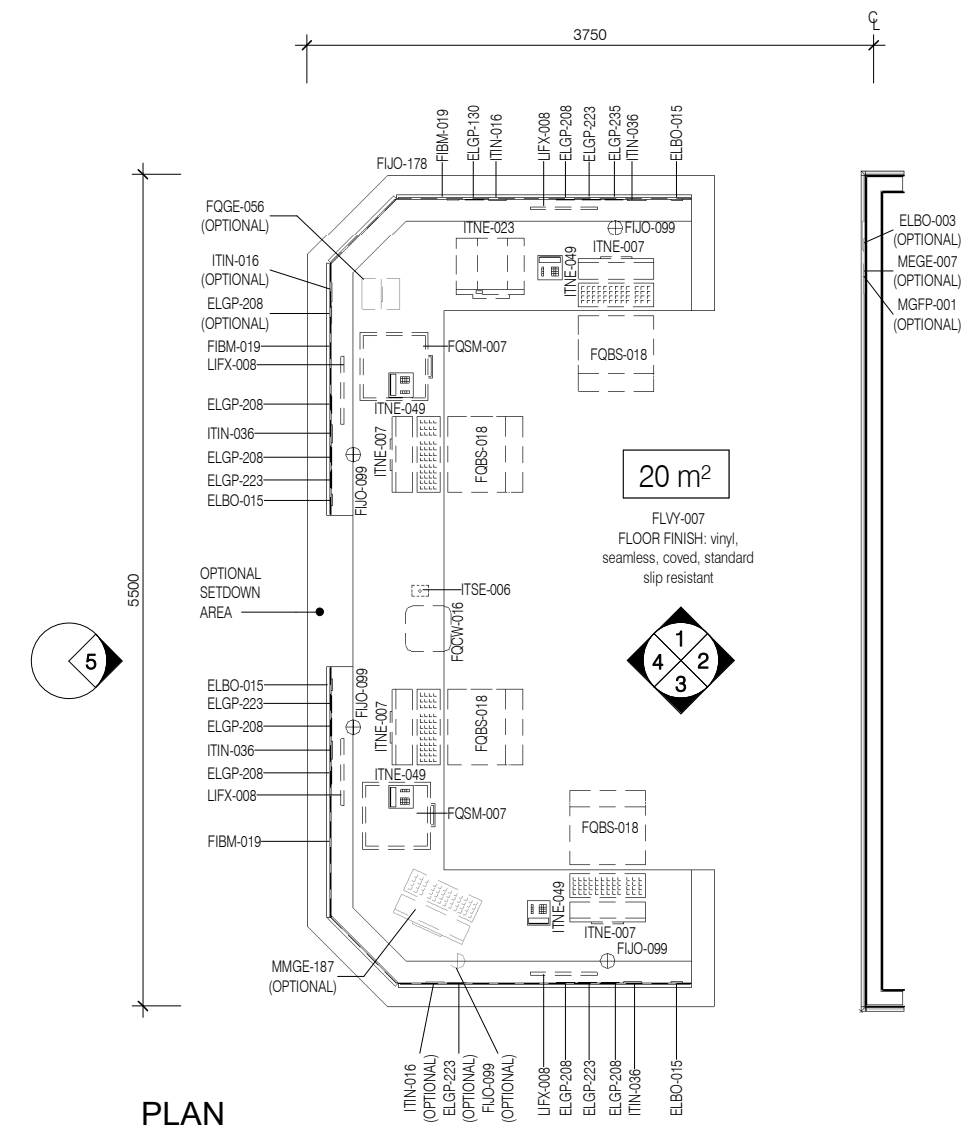

NOTE: ONE COMPUTER HAS BEEN NOMINATED AS A DOWNTIME COMPUTER WITH UPS POWER AND THIS REQUIREMENT WILL NEED TO BE CONFIRMED. THE DOWNTIME COMPUTER, IF REQUIRED BY A UNIT, MAY ALTERNATIVELY BE PROVIDED IN A CLINICAL WORKROOM. PROVISION OF A DOWNTIME COMPUTER WILL NEED TO BE RATIONALISED ACROSS THE UNIT.

ANY ROOMS THAT ARE ACCESSED FROM BEHIND THE STAFF STATION WILL REQUIRE ADDITIONAL AREA FOR APPROPRIATE DOOR CIRCULATION CLEARANCE.

REV	DESCRIPTION	DATE
5	General update following ERG review	28.06.2021

FOR GUIDANCE

SCALE	RLS Room Code	REV
1 : 50 @ A3	SSTN-20	5

AUSTRALASIAN HFG STANDARD COMPONENTS

Room Layout Sheet

RLS Room Code: **SSTN-20**

Room Name:

STAFF STATION, 20m²

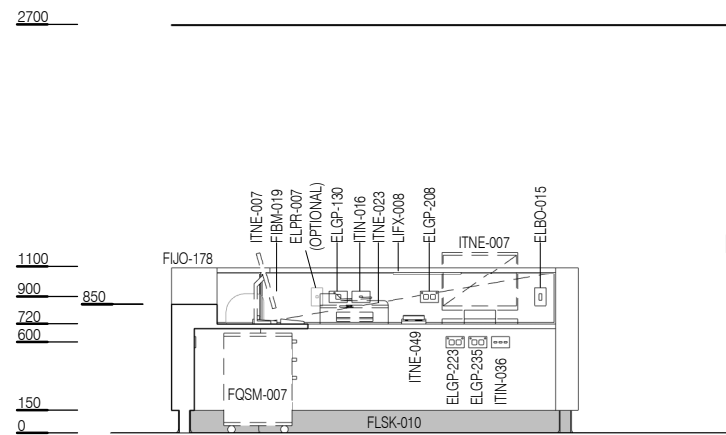
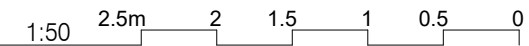

ELEVATION 1

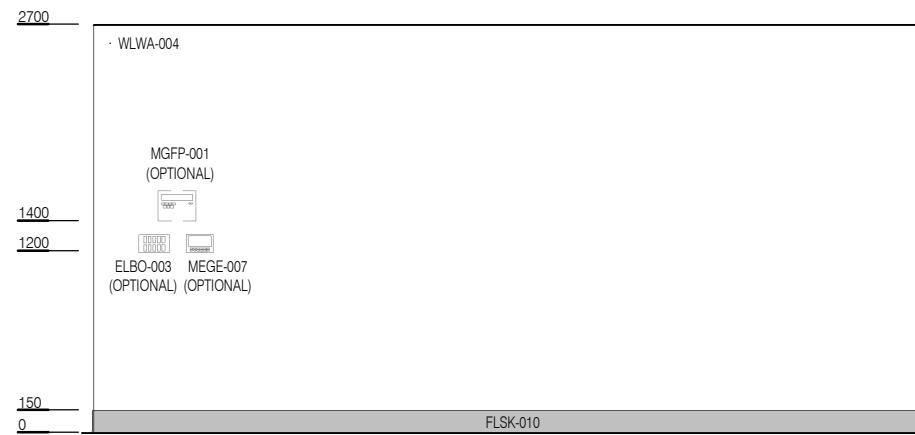

ELEVATION 2

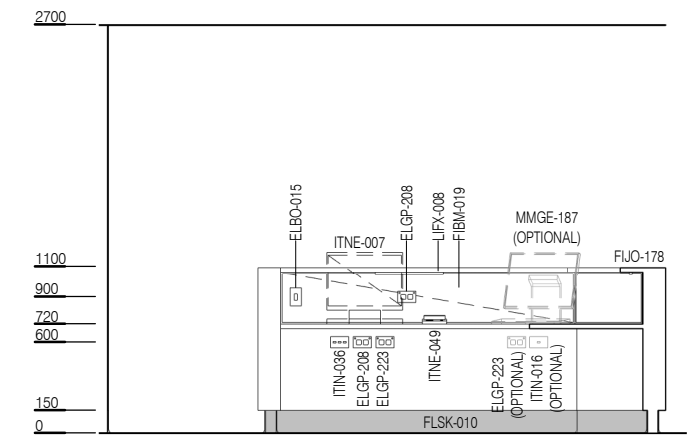

ELEVATION 3

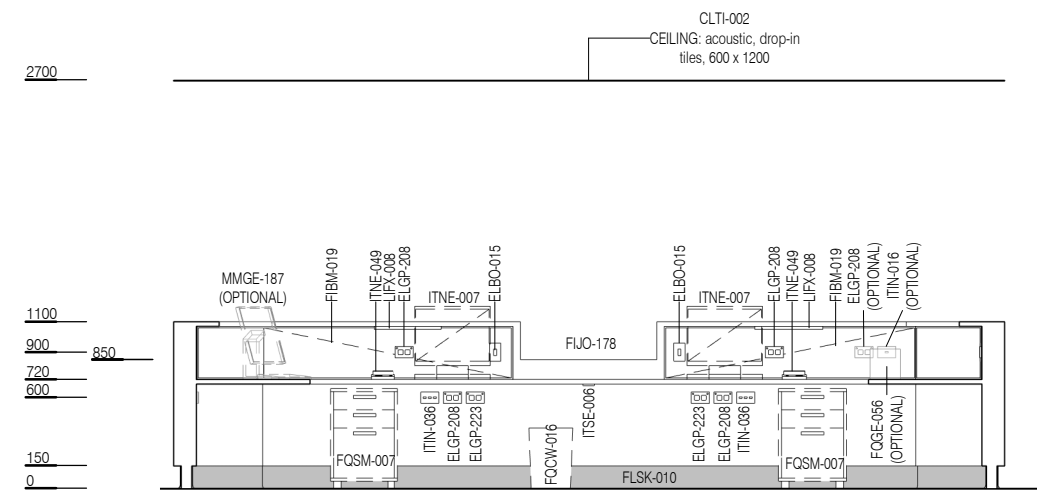

ELEVATION 4

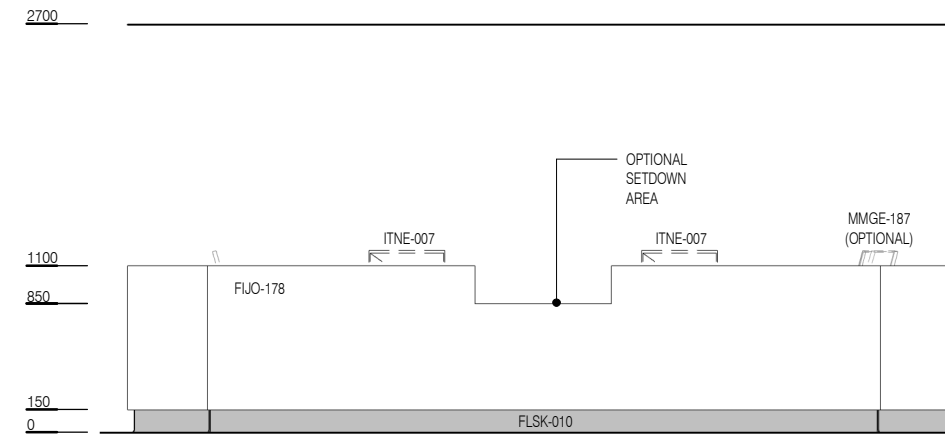

ELEVATION 5

CODE	DESCRIPTION
ELBO-003	CONTROL PANEL: lighting
ELBO-015	SWITCH: light, single
ELGP-130	GPO: UPS, single
ELGP-208	GPO: double, wall mounted
ELGP-223	GPO: emergency power, double, wall mounted
ELGP-235	GPO: UPS, double, wall mounted
ELPR-007	UPS: status indicator
FIBM-019	WHITEBOARD: fixed, magnetic
FQSM-007	PEDESTAL: mobile, drawer unit, 660H
FQBS-018	CHAIR: office, ergonomic
FQCW-016	BIN: waste, general, 20L
FQGE-056	PRINTER: desktop, labels

CODE	DESCRIPTION
FQSM-007	PEDESTAL: mobile, drawer unit, 660H
ITIN-016	OUTLET: data, single RJ45, wall mounted
ITIN-036	OUTLET: data, triple RJ45, wall mounted
ITNE-007	COMPUTER: desktop, with display screen
ITNE-023	PRINTER: networked
ITNE-049	TELEPHONE: handset, desktop
ITSE-006	BUTTON: duress, fixed
LIFX-008	LIGHT: task light, built in
MEGE-007	CONTROL PANEL: temperature
MGFP-001	ALARM PANEL: medical gases
MMGE-187	MONITOR: patient, central monitoring
WLWA-004	WALL FINISH: paint, acrylic, washable



REV	DESCRIPTION	DATE
5	General update following ERG review	28.06.2021

FOR GUIDANCE

SCALE	RLS Room Code	REV
1 : 50 @ A3	SSTN-20	5