

AUSTRALASIAN HFG STANDARD COMPONENTS

Room Layout Sheet

RLS Room Code: TRMT-RD-A

Room Name:

TREATMENT BAY - RENAL DIALYSIS - TYPE A

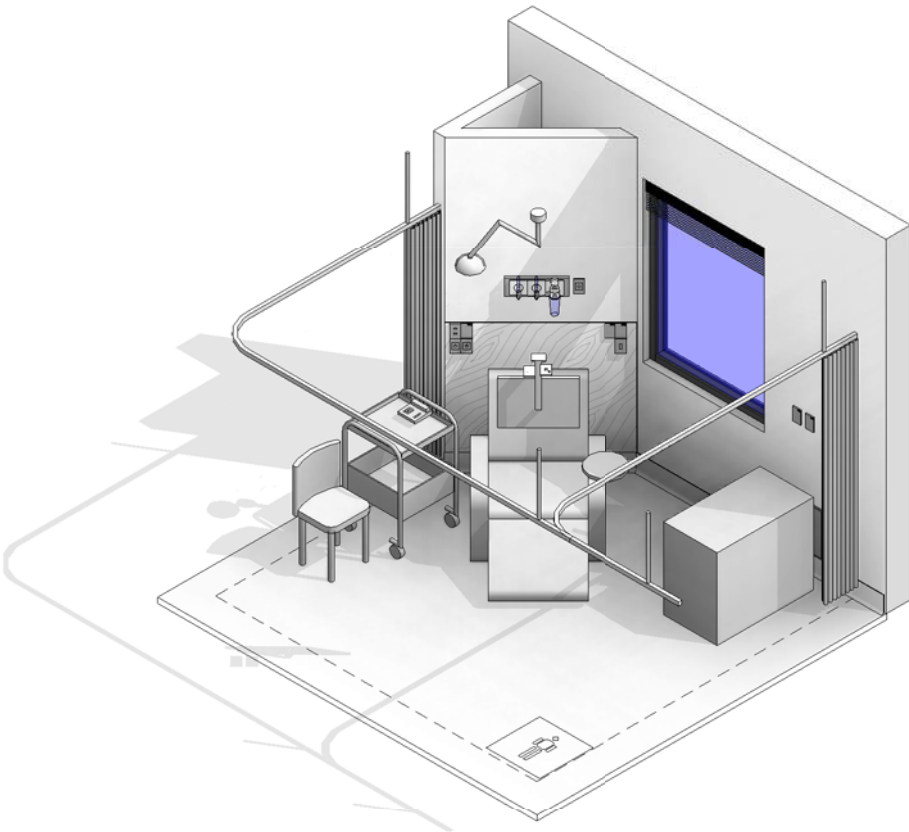
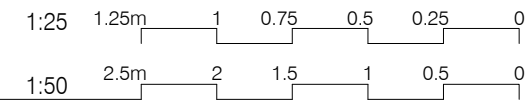

BIMID	DESCRIPTION
2000	FLOOR VINYL COVERED SKIRTING
3092	WALL PROTECTION
7001	WINDOWS
FE-5857	LIGHT PROCEDURE - SMALL CEILING MOUNTED
FE-15980	DIALYSIS MACHINE
FE-15985	DIALYSIS STATION
FE-54510	TELEPHONE - HANDSET, STANDARD
FF-150	AIR FLOWMETER
FF-1250	EXTERNAL WINDOW DRESSING - FF-1250
FF-1465	BRACKET - SUCTION BOTTLE
FF-2201	RECLINER - WITH ATTACHED SIDE TABLE
FF-2650	CHAIR - VISITOR, PATIENT
FF-4600	CURTAIN TRACK - BED SCREEN
FF-5000	CURTAIN - BED SCREEN
FF-5547	PATIENT ENTERTAINMENT
FF-5825	BRACKET - PATIENT ENTERTAINMENT, CEILING
FF-7402	TROLLEY - TREATMENT BAY
FF-16250	OXYGEN FLOWMETER
FF-21950	SUCTION ADAPTER
FF-22000	SUCTION BOTTLE
S-1006	VOICE DATA OUTLET - DOUBLE
S-1090	TV - MATV
S-1951	STAFF ASSIST CALL
S-4037	TUNDISH DRAIN
S-4045	REVERSE OSMOSIS (RO) WATER OUTLET
S-6200	LIGHT SWITCH
S-7000	MEDICAL GAS OUTLET - OXYGEN
S-7020	MEDICAL GAS OUTLET - MEDICAL AIR
S-7040	MEDICAL GAS OUTLET - SUCTION
S-8000	PATIENT TO STAFF CALL
S-8080	EMERGENCY CALL
S-9001	GENERAL POWER OUTLET - DOUBLE
S-9010	EMERGENCY POWER OUTLET - SINGLE
S-9015	GENERAL POWER OUTLET - CLEANER
S-9040	BODY PROTECTED
S-11000	MEDICAL SERVICES PANEL
S-9000200	GENERAL POWER OUTLET - SPECIAL MOUNT ON CEILING
S-9001650	GENERAL POWER OUTLET - DOUBLE (RCD PROTECTED)

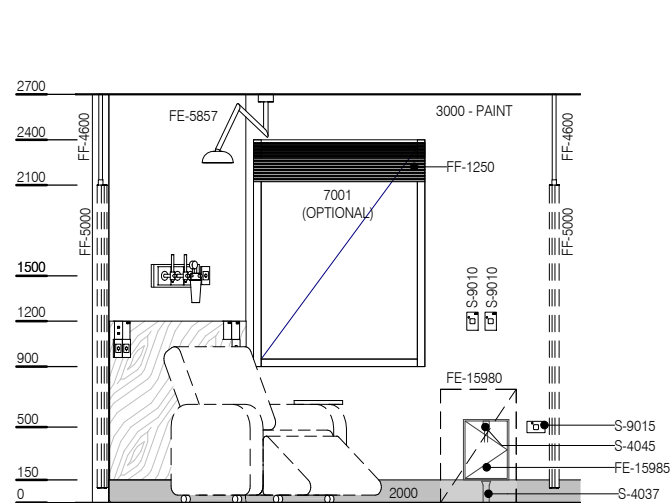
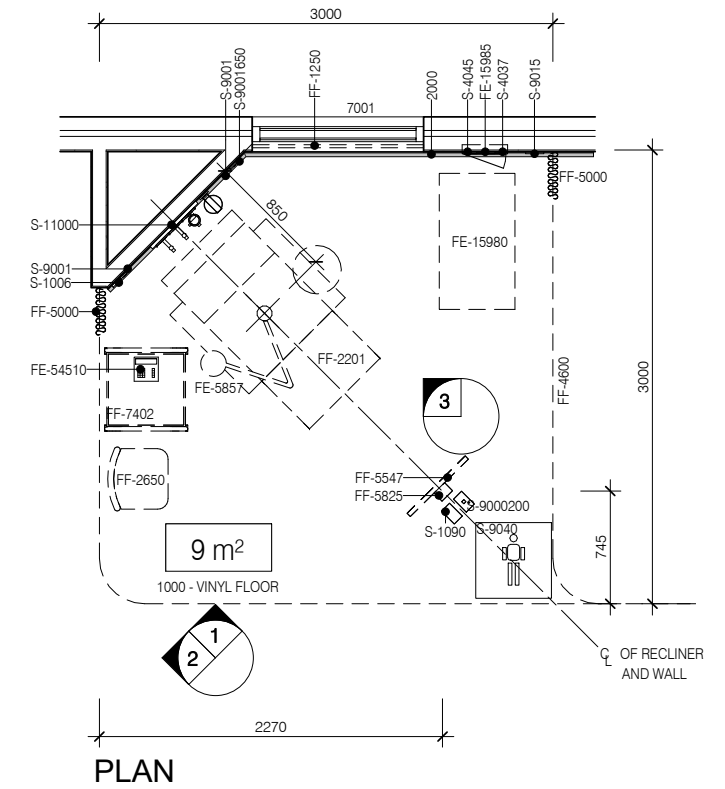

ELEVATION 1

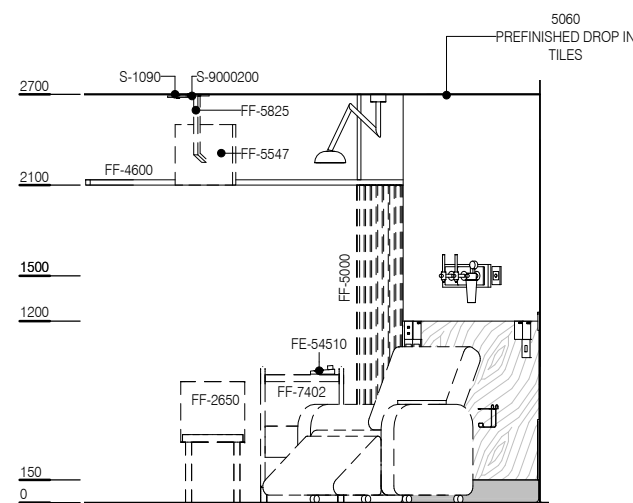

ELEVATION 2

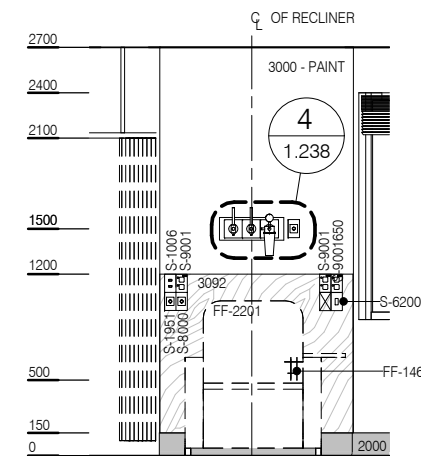

ELEVATION 3

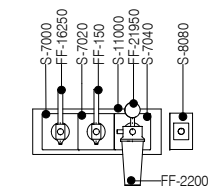

ELEVATION 4 (1:25 @ A3)



REV	DESCRIPTION	DATE
3	This RLS has been redocumented	01.03.2016

FOR GUIDANCE

SCALE	RLS Room Code	Room Tag	REV
1 : 50 @ A3	TRMT-RD-A	1.238	3